

AVIGILON™

Installation Guide

Avigilon™ 4-Door ACM™ Embedded Controller Kit

AC-HID-LSP-ACMEC-KIT4

© 2015, Avigilon Corporation. Portions © 2003 - 2014 HID Global Corporation. All rights reserved. AVIGILON, the AVIGILON logo, ACCESS CONTROL MANAGER and ACM are trademarks of Avigilon Corporation. HID, VertX, V100, V200 and V300 are registered trademarks of HID Global Corporation. Other product names mentioned herein may be the trademarks of their respective owners. The absence of the symbols ™ and ® in proximity to each trademark in this product or its packaging is not a disclaimer of ownership of the related trademark.

Unless stated explicitly and in writing, no license is granted with respect to any copyright, industrial design, trademark, patent or other intellectual property rights of Avigilon Corporation or its licensors.

This document has been compiled and published covering the latest product descriptions and specifications. The contents of this document and the specifications of the products discussed herein are subject to change without notice. Neither Avigilon Corporation nor any of its affiliated companies guarantees the completeness or accuracy of the information contained in this document and is not responsible for your use of, or reliance on, the information. Avigilon Corporation shall not be responsible for any damages (including consequential damages) caused by reliance on the information presented herein.

Avigilon Corporation
<http://www.avigilon.com>

220-0453C

Revision: 1 - EN

20151112

Regulatory

Prior to installation, it is necessary to find a suitable site indoors (this product should always be installed indoors). It is assumed that the installer has required certifications and required permits. The Installer must follow electrical standards and AHJ requirements.

All National and local Electrical codes apply.

- This equipment is intended to be powered from a limited power source output of a previously certified power supply.
- Changes or modifications not expressly approved by the party responsible for compliance could void the user's authority to operate the equipment.

Class A Digital Devices

FCC Compliance Statement: This equipment has been tested and found to comply with the limits for a Class A digital device, pursuant to part 15 of the FCC Rules. These limits are designed to provide reasonable protection against harmful interference when the equipment is operated in a commercial environment. This equipment generates, uses, and can radiate radio frequency energy and, if not installed and used in accordance with the instruction manual, may cause harmful interference to radio communications. Operation of this equipment in a residential area is likely to cause harmful interference in which case the user will be required to correct the interference at his own expense.

Canada Class A

CE Mark – Europe (EU)

C-Tick – Australia and New Zealand

VCCI – Japan

NCC – Taiwan

SRRC— China

IDA – Singapore

KCC – Korea

UL Recognized Component (UL294 and UL1076)

RoHS compliant

Table of Contents

Introduction	5
Package Contents	5
Installation	6
Mounting the Control Panel Case	7
Power Supply Board Overview	9
Setup the FPO75 Power Supply Board	9
Setup the B100 Power Supply Board	11
Setup the D8P Power Supply Board	11
Setup the C4 Power Supply Board	12
Install the ACM Embedded Controller and V100 Subpanels	13
Configure and Wire Data	14
Configure and Wire Power	17
Power On	19
Accessing ACM Embedded Controller Application for the First Time	20
By Virtual Port	20
By Host Name	20
Checklists	21
Tools Checklist	21
Equipment Checklist	21

Introduction

The Access Control Manager (ACM) Embedded Controller from Avigilon is an all-in-one security management application and controller.

The ACM Embedded Controller is a controller embedded with the ACM Embedded Controller application to provide a flexible and scalable platform for an economic and high performance access control system.

The controller uses a standard TCP/IP network to connect to a browser interface which links to the ACM Embedded Controller application. The application allows you to effectively control access at each entry point.

Package Contents

The package contents for the 4-Door ACM Embedded Controller are:

- One AC-LSP-4DR-HID-LCK LifeSafety Power four door HID dual voltage integrated power system (shipped in a separate box)
- One Avigilon AC-HID-ACMEC V1000 ACM Embedded Controller
- Two AC-HID-VERTEX-V100 reader interface modules
- Four AC-HID-READ-ICLASS-SE-R10-AVG card readers
- 100 AC-HID-CARD-ICLASS-SE-3000-AVG contactless smart card, 2k bit with two application areas

Installation

Before you install the ACM Embedded Controller, read through this entire document.

Refer to the checklist at the end of this document and gather the required information before proceeding with these instructions.



CAUTION — The controllers and interface panels are sensitive to Electrostatic Discharges (ESD). Observe precautions while handling the circuit board assembly by using proper grounding straps and handling precautions at all times.

Mounting the Control Panel Case

Follow the steps below to mount the control panel case.

1. At the installation site, remove the control panel case from the LifeSafety Power FlexPower box.
2. Find two studs in the wall where the enclosure should be installed.
NOTE: In a finished setup, the enclosure and contents together weighs 11.8kg (26lb).
3. Mount the plywood board onto the wall at the desired location.
NOTE: It is highly recommended that the plywood board is mounted to two studs. If no studs are available, use appropriate drywall anchors that can support the enclosure.
4. Remove one of the two high voltage knockouts.
5. Attach an appropriate cable gland to the 7/8" diameter high voltage opening.
6. Mount the enclosure to plywood using six wood screws.

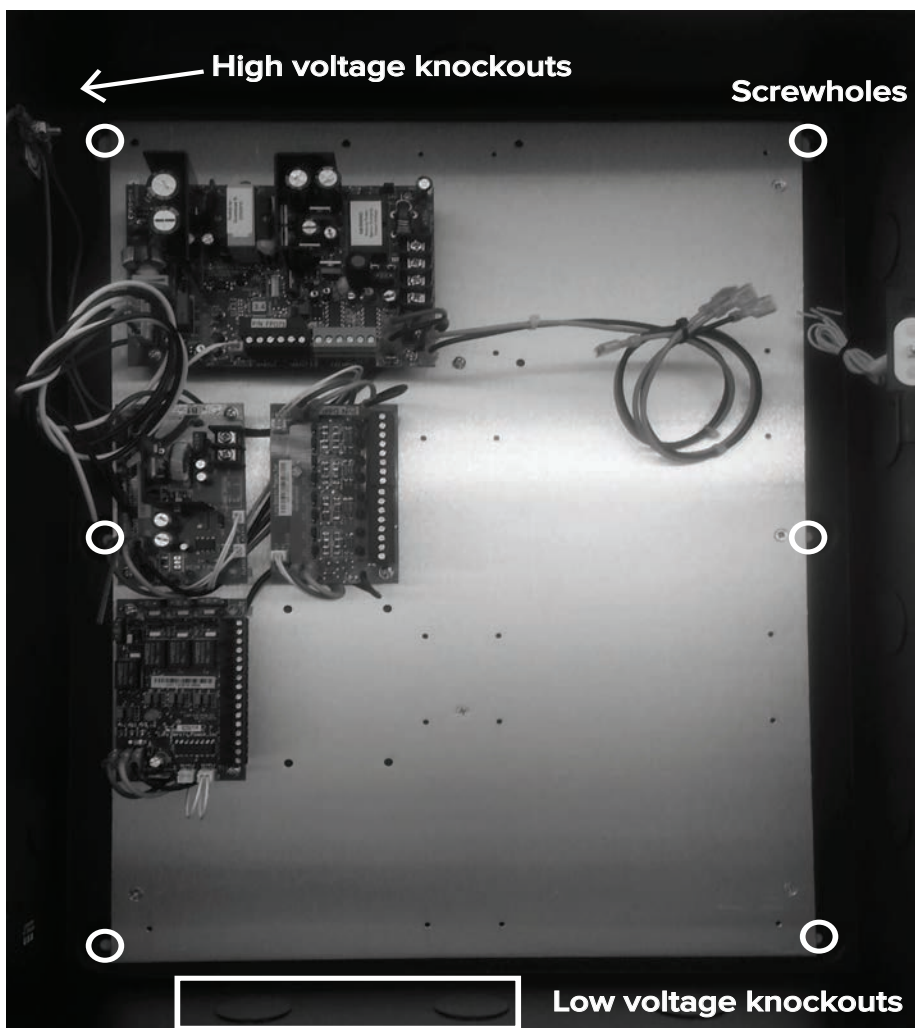

7. Setup the high voltage junction box (or equivalent), as required. Attach an appropriate cable gland to the junction box and feed the three AC wires through.

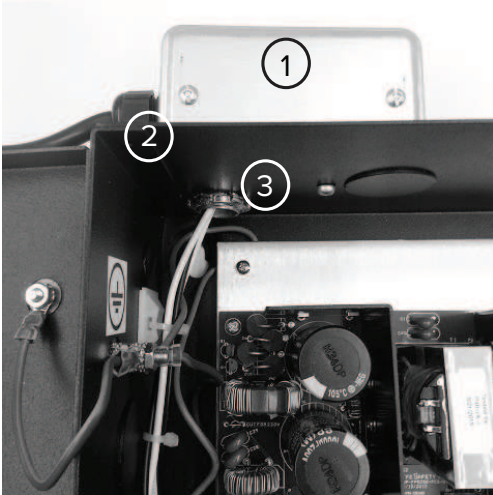

KEY: 1 is a sample high voltage junction box, while 2 and 3 are sample cable glands.



CAUTION — Do not connect to the main power supply yet.

8. Remove knockout(s) for low voltage input/output wires, as necessary.
9. Attach an appropriate cable gland to each 1 3/8" diameter low voltage opening.

Power Supply Board Overview

Shown below is an overview of the power supply board.

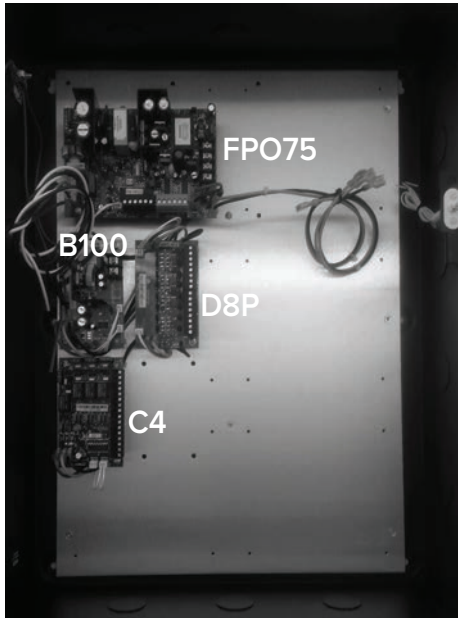

Setup the FPO75 Power Supply Board

Follow the steps below to setup the FPO75 power supply board:

1. Either:
 - For 120V input, leave JP1 intact.
 - For 230V input, cut JP1.



CAUTION — Failure to cut this jumper when using the FPO with a 230VAC input will result in damage to the system and will void the warranty.



2. Ensure the DC output jumper is set to 24V (as circled below).

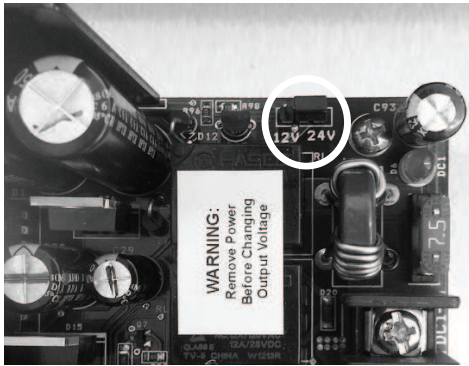

CAUTION — Failure to set the FPO75's DC output jumper to 24V will likely result in damage to the system and will void the warranty.

3. Connect the inputs on the FAI (Fire Alarm Input) to the building's fire alarm system, as required. See the FPO Quick Start Manual (page 3 – FAI Input Usage) for more detail. Further information is available at: http://lifesafetypower.com/docs/im_fpo.pdf.

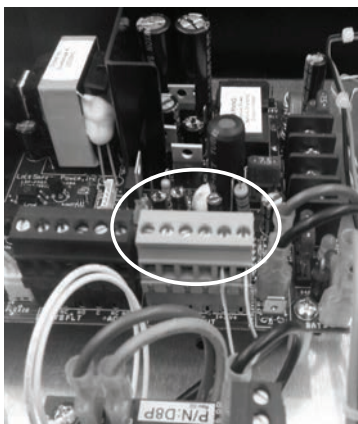

4. Either:
 - If a backup battery is used – move the jumper to position 1, as shown below.
 - If no backup battery is used – move the jumper to position 2.

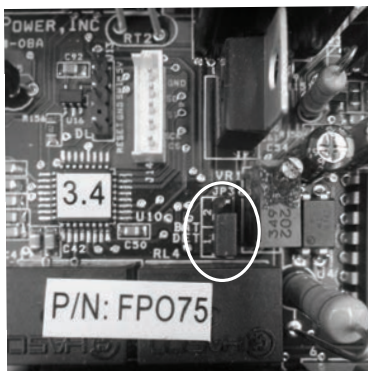

Setup the B100 Power Supply Board

On the B100 board, ensure Output Voltage Selection jumper (JP3) is set to position 1 for 12VDC out, as shown below.

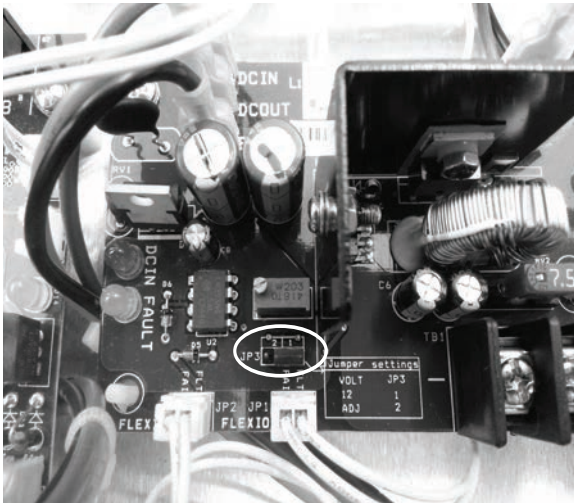

See the B100 Quick Start Manual or B100 Installation Manual for more detail (available at http://www.lifesafetypower.com/docs/im_b100.pdf).

Setup the D8P Power Supply Board

On the D8P board, set the JP1 to 4 output voltage selection jumpers to provide 12VDC.

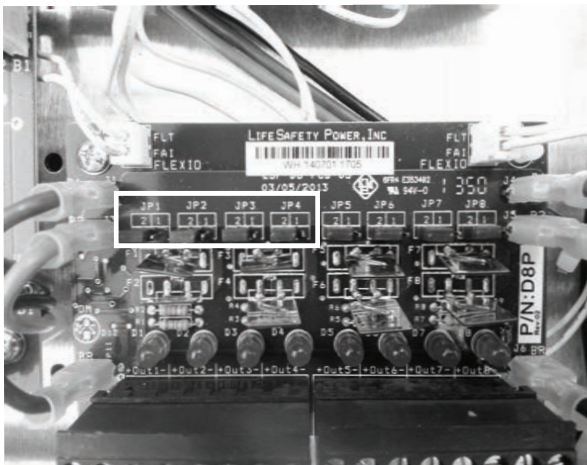

See the D8 Quick Start Manual or D8/D8P Installation Manual for more detail (available at http://www.lifesafetypower.com/docs/im_d8.pdf).



CAUTION — Failure to set the JP1 to 4 jumpers may cause damage to components.

Setup the C4 Power Supply Board

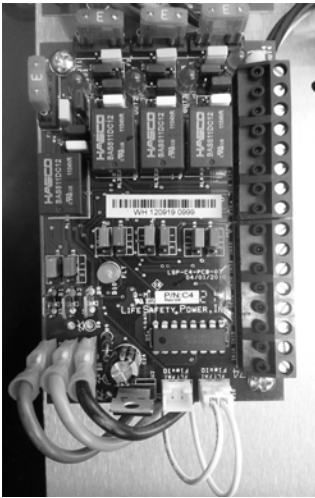

Set the jumpers properly for your installation as outlined below:

Jumpers	Position
Red - 1A to 4A (Zone FAI enabled)	Either: <ol style="list-style-type: none"> 1. FAI enabled 2. FAI disabled
Blue - 1B to 4B (Input Invert)	Either: <ol style="list-style-type: none"> 1. Fail Safe (NC contact input) 2. Fail Secure (NO contact input)
Black - 1C to 4C (Wet Output Selection)	Either: <ol style="list-style-type: none"> 1. Relay Contact Output 2. Voltage Output
Yellow - 1D to 4D (Voltage Bus Selection)	Either: <ol style="list-style-type: none"> 1. B1 Bus 2. B2 Bus
Black - 1E to 4E (Dry Output Selection)	Either: <ol style="list-style-type: none"> 1. Relay Contact Output 2. Voltage Output
White - 1F to 4F (Output Invert)	Either: <ol style="list-style-type: none"> 1. NO - voltage when input is activated 2. NC - voltage when input is deactivated

See the C4/C8 Quick Start Manual or C4/C4P C8/C8P Installation Manual for more detail (available at http://www.lifesafetypower.com/docs/im_c4c8.pdf).

Install the ACM Embedded Controller and V100 Subpanels

Shown below is an overview of the positioning of the ACM Embedded Controller and V100 subpanels.

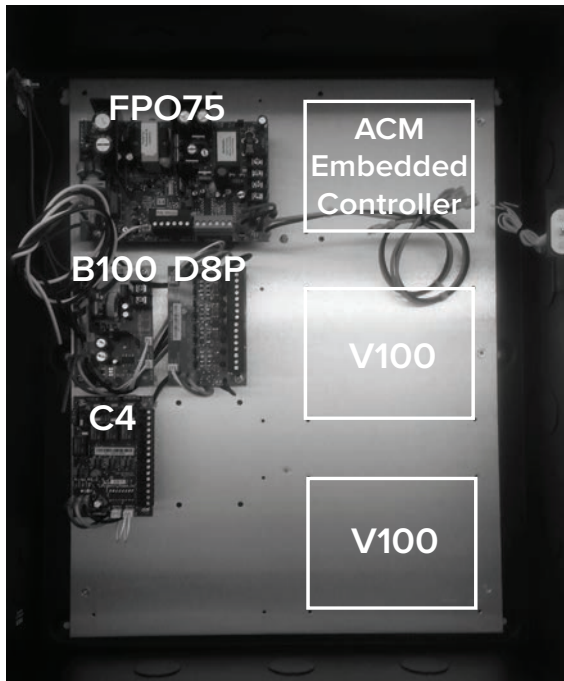

Install the ACM Embedded Controller and V100 subpanels as shown below:

1. Unbox the Avigilon ACM Embedded Controller and V100 subpanels.
2. Locate 12 screws from the accessory bag in the FlexPower box.
3. Verify battery jumper (Batt) on the ACM Embedded Controller has been set to ON position.

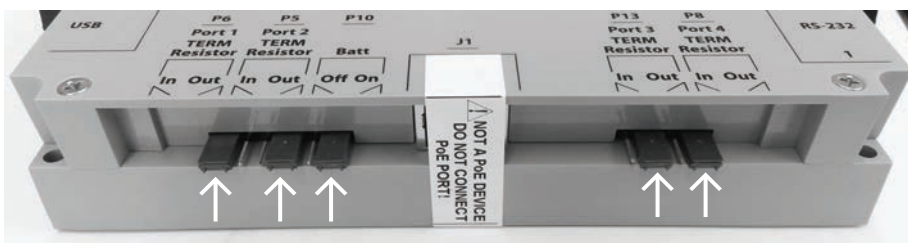

CAUTION — This is a non-PoE device. Do not connect J1 (Ethernet port) to a PoE-capable port. This applies to both direct PoE Power Sourcing Equipment (Endspan PSE) and PoE injector (Midspan PoE) equipment. Not all PSE's correctly detect non-PoE capable devices, and such PSE's may not function as expected when connected to non-PoE equipment.

4. Set Port 1 terminating jumper (P6 Port 1 TERM Resistor) to IN position.
5. Verify Port 2, 3, 4 terminating jumpers are in the OUT position.

6. Mount the ACM Embedded Controller as shown below (the arrows show screws).

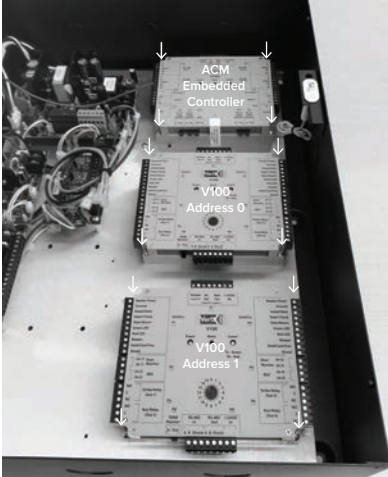

7. Mount the V100 subpanels as shown in step 4.
8. Using a small slotted screwdriver gently turn the V100 addresses as follows:
 - Set the top V100 to Address 0 (as shown in step 4).
 - Set the bottom V100 to Address 1 (as shown in step 4).

NOTE: Always use stranded wires - the recommended gauges are:

- 18 AWG – low voltage power wires.
- 22 AWG – data wires.

Configure and Wire Data

Follow the steps below to configure and wire the ACM Embedded Controller:

1. Connect the white enclosure tamper wires to Tamper +/- on the ACM Embedded Controller. Polarity does not matter.

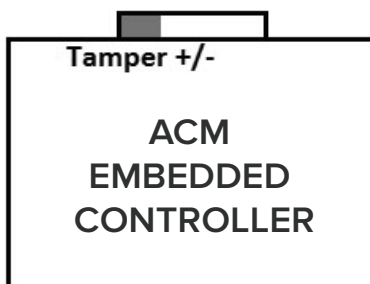

- Using 18 AWG wires (red for + and black for -), wire the 12-24VDC input to +Out1- on the D8P board's terminal block.

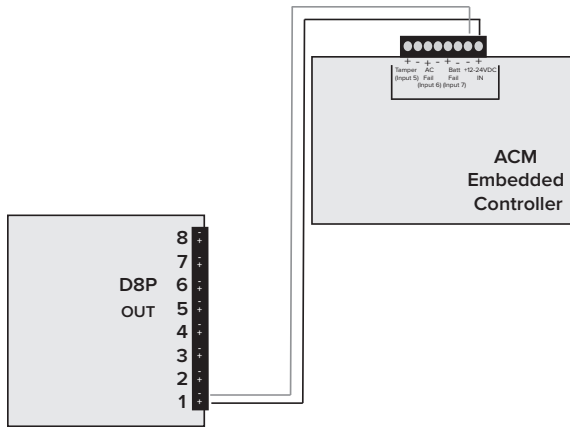

- On the FPO75's SYSFLT terminal block:

- Wire C to Batt Fail + (22 AWG).
- Wire NO to Batt Fail - (22 AWG).

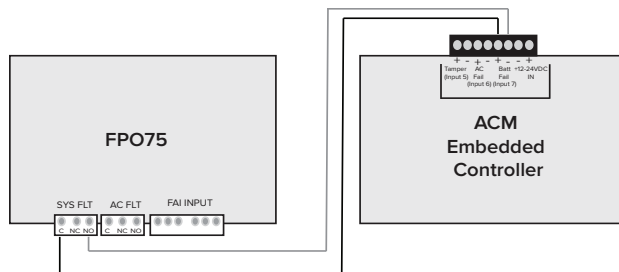

- On the FPO75's ACFLT terminal block:

- Wire C to AC Fail + (22 AWG).
- Wire NO to AC Fail - (22 AWG).

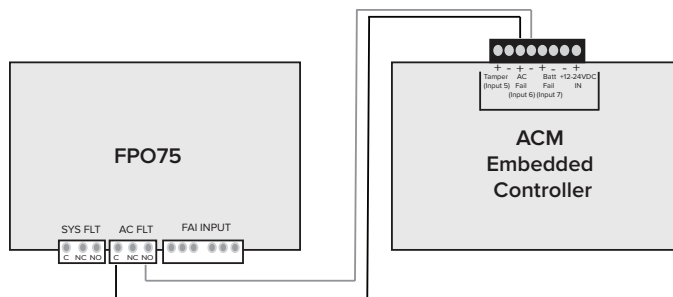

- Starting from the ACM Embedded Controller's P3 RS-485 Port1 terminal block, connect the A, B, and Shield inputs to the V100 Subpanels as shown below (22 AWG).

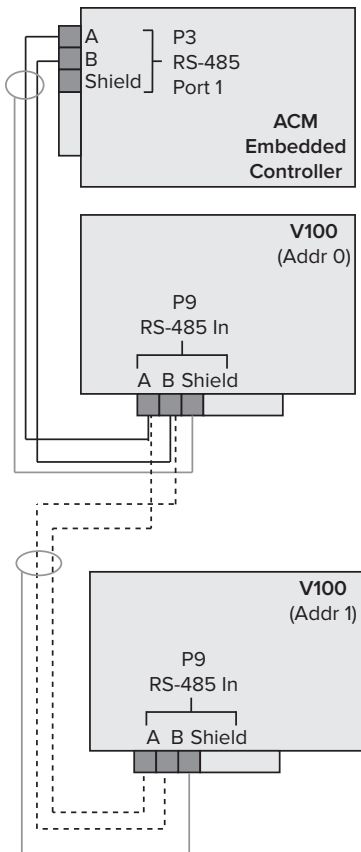

NOTE: On the V100s make sure to use the RS-485 In; avoid using the RS-485 Out.

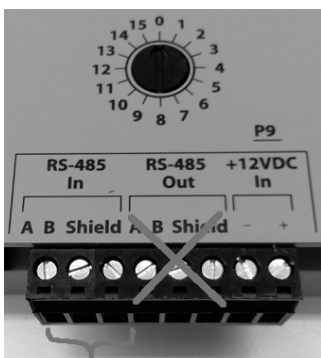

Configure and Wire Power

Do the following for each V100 in order for the ACM Embedded Controller application to not show an alarm:

1. Place a jumper across Tamper + and - (22AWG).
2. Place a jumper across AC Fail + and - (22AWG).
3. Place a jumper across Batt Fail + and - (22AWG).
4. Connect the 12VDC +/- to the D8P board (18AWG), as noted below:
 - Connect the Addr 0 V100 12VDC + to Out2+ and - to Out2-.
 - Connect the Addr 1 V100 12VDC + to Out3+ and - to Out3-.

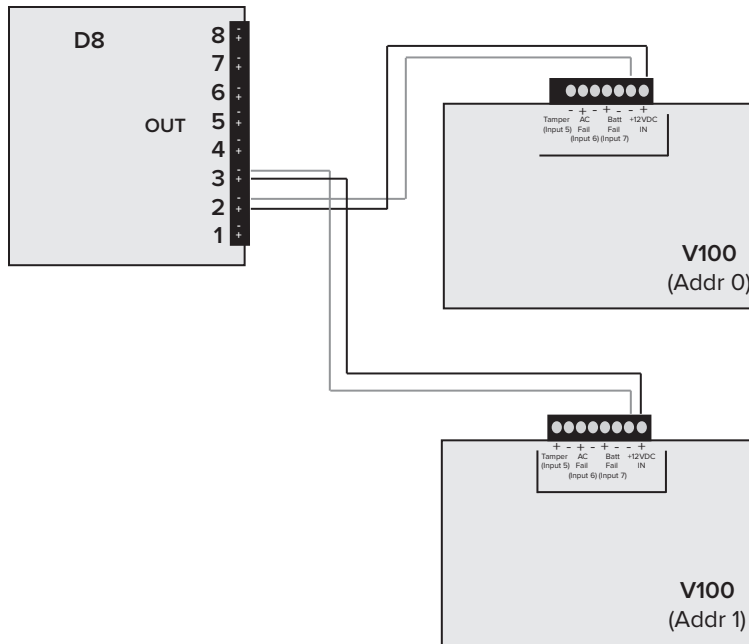

NOTE: For steps below ensure that the card reader, door monitor (if available), request-to-exit (if available) and lock wiring from the door are fed into the power supply enclosure and route to the corresponding port on each V100 as desired.

5. If door monitors are available, connect them appropriately to P2\Door Monitor and P5\Door Monitor. (Refer to the Door Monitor manual.)

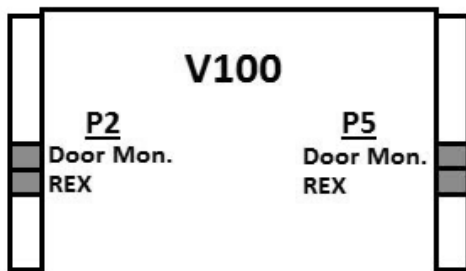

- If request-to-exit inputs from the door are available, connect them appropriately to the P2\REX and P5\REX. (Refer to the appropriate Request-to-Exit device manual.)

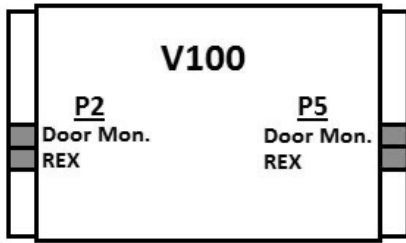

- Connect cabling from the R10 readers at the door to the appropriate P1/P4 reader connection on the V100.

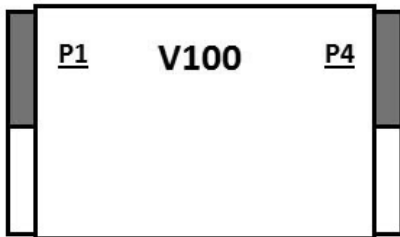

- Wire the V100s' strike relay outputs to the C4 board inputs as shown below:

NOTE: Shown below is the recommended configuration.

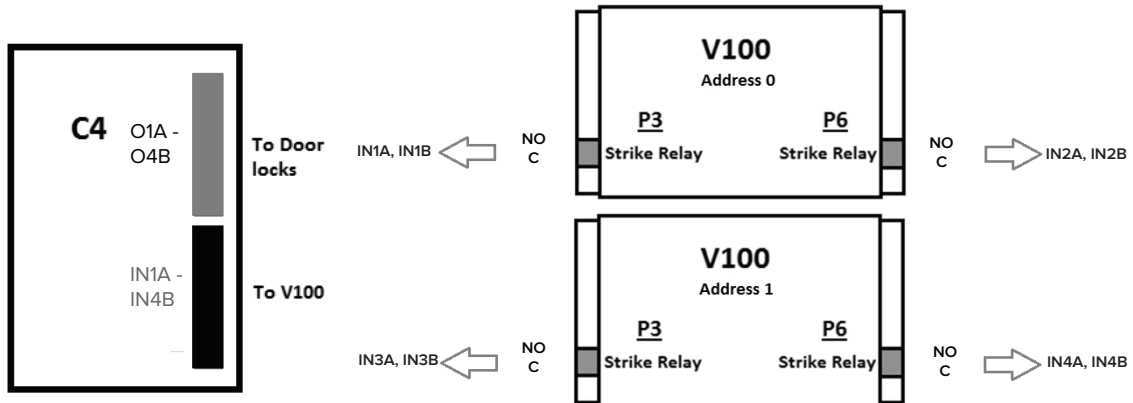

Using the default C4 configuration:

V100 Strike Relay configuration	Locked	Unlocked
NO/C (recommended)	0V	24V
C/NC (alternate option)	24V	0V

If deviation from the default configuration is desired, see the C4/C8 Quick Start Manual or C4/C4P C8/C8P Installation Manual for more detail (available at http://www.lifesafetypower.com/docs/im_c4c8.pdf).

- Wire the C4 board's outputs 1 to 4 to their corresponding door locks. (See the C4/C8 and Door Lock manuals for more detail.)

Power On

Follow the steps below to power on and verify the installation:

Note: Once connected, the card readers may beep – this will go away once the ACM Embedded Controller has been configured.

1. Connect the High Voltage AC input to the main power supply.



CAUTION — Take necessary precautions when handling high voltage wiring.

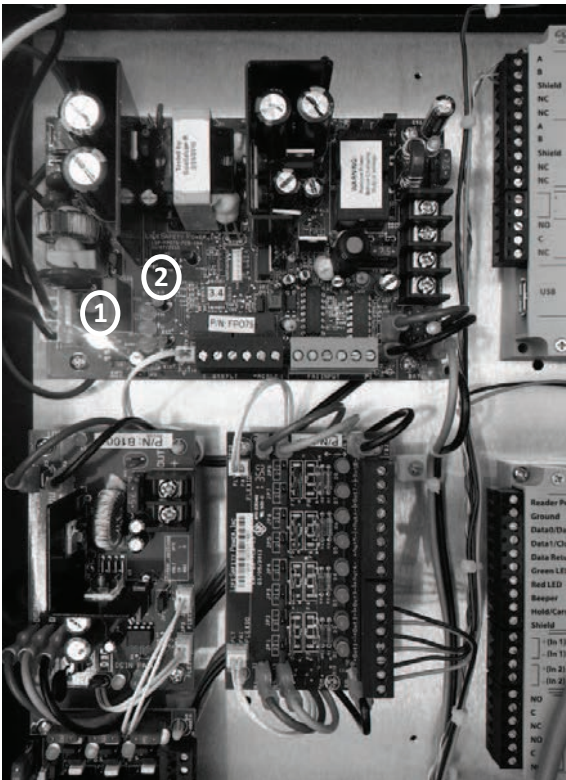

NOTE: On the FPO75 PSU the AC light (green - see 1 above) should be on and all warning lights (see 2 above) should be off.

2. Connect the battery set(s), if applicable. See the FPO Quick Start Manual (page 1 – Battery Terminal Connection) for more detail. Further information is available at: http://lifesafetypower.com/docs/im_fpo.pdf.



CAUTION — Observe battery polarity or damage to the system will occur.

3. Connect the ACM Embedded Controller J1 Ethernet port to a laptop or desktop computer (preferably offline as if you are networked the network may interfere with the IP address).



CAUTION — Do not connect the ACM Embedded Controller to a PoE port.

Accessing ACM Embedded Controller Application for the First Time

After the controller has been installed, you need to access the ACM Embedded Controller application to complete the system configuration.

You can access the application by using the controller hostname or virtual port.

By Virtual Port

By default, every controller can be accessed from this IP address: 169.254.242.121

To perform this procedure, you must use a Windows computer with a web browser and a network port.

1. Disconnect the computer from the network.
2. Connect the computer to the controller using an Ethernet cable.
3. On your computer, open command prompt.
4. Enter `ipconfig/renew`

Wait for DHCP to timeout (approximately 60 seconds). The computer will acquire a 169.254.x.x address.

5. Open a web browser and enter this address: 169.254.242.121

The controller is now accessible through this virtual port.

6. Enter your login for the application.

The default username and password is `admin`.

By Host Name

To access the ACM Embedded Controller application by this method, your DHCP server must support hostname access and only have one controller in the local area network (LAN).

1. Make sure the controller has a LAN connection.
2. Power the controller and wait 60 seconds for the controller to start up.
3. In a web browser, enter this address: `https://acm-ec.<network domain>`

For example: `https://acm-ec.example.lan`

The controller is now accessible through this URL.

4. Enter your login for the application.

The default username and password is `admin`.

See the *ACM Embedded Controller Installation Guide* or the *ACM Embedded Controller User Guide* for more detail.

Checklists

The checklists below identify the tools and equipment required for installation.

Tools Checklist

The following tools are required:

	Tool	Required/Recommended/Optional
<input type="checkbox"/>	Stud finder	Required
<input type="checkbox"/>	Cordless drill or large screwdriver	One required - drill is recommended
<input type="checkbox"/>	Various drill bits	Required
<input type="checkbox"/>	Needle nose pliers	Required
<input type="checkbox"/>	Small slotted screwdriver (1/8" or less)	Required
<input type="checkbox"/>	Small hammer	Required
<input type="checkbox"/>	Wire cutter	Required
<input type="checkbox"/>	Wire stripper	Required
<input type="checkbox"/>	Laptop	Recommended
<input type="checkbox"/>	Multi-meter	Optional

Equipment Checklist

The following equipment is provided:

	Tool	Required/Recommended/Optional
<input type="checkbox"/>	One AC-LSP-4DR-HID-LCK LifeSafety Power four door HID dual voltage integrated power system (supplied in a separate shipping box)	Required
<input type="checkbox"/>	One Avigilon AC-HID-ACMEC V1000 ACM Embedded Controller	Required
<input type="checkbox"/>	Two AC-HID-VERTEX-V100 reader interface modules	Required
<input type="checkbox"/>	Four AC-HID-READ-ICLASS-SE-R10-AVG card readers	Required
<input type="checkbox"/>	100 AC-HID-CARD-ICLASS-SE-3000-AVG contactless smart card, 2k bit with two application areas	Required

The following equipment is also required:

	Tool	Required/Recommended/Optional
<input type="checkbox"/>	One Plywood board 4' x 4' (½" to ¾" thick). Fire rated recommended.	Required
<input type="checkbox"/>	Four Wood screws (sizing as required)	Required
<input type="checkbox"/>	Four Drywall anchors (sizing as required)	Required
<input type="checkbox"/>	High voltage wiring (sizing as required)	Required
<input type="checkbox"/>	One cable gland for 7/8" (high voltage opening)	Required
<input type="checkbox"/>	One-plus cable gland(s) for 1 3/8" (low voltage opening)	Required
<input type="checkbox"/>	18 AWG stranded wiring	Required
<input type="checkbox"/>	22 AWG stranded wiring	Required
<input type="checkbox"/>	Ethernet Cat5e+ cable	Required
<input type="checkbox"/>	One to two sets of 2x 12V backup batteries in series to deliver 24V power	Optional. Backup batteries provide the ability to power the system in case of power outage. For more information refer to Section 3 - Specifications of the DC Power System Installation Manual at: www.lifesafetypower.com/docs/im_fpo.pdf .
<input type="checkbox"/>	Cable ties	Optional